

A Long Lasting Technology

Breakage of a screwdriver bit not only reduces work efficiency but also adversely affects the quality of an assembled product. Improving durability of a screwdriver bit is a critical issue for assembly lines.

Pursuit of Durability

Alloy Steel including substances such as C, Si, Ni, Cr, Mo, and V, which gives a high hardness and toughness, is heat treated by our own furnace and technology in order to make our screwdriver bits outstanding quality and durability.

“VoHA” steel is compounded a special alloy element used for materials in aerospace industry. Combination with NECK TORSION™ technology, it is possible to dramatically reduce the breakage of the bit tip.

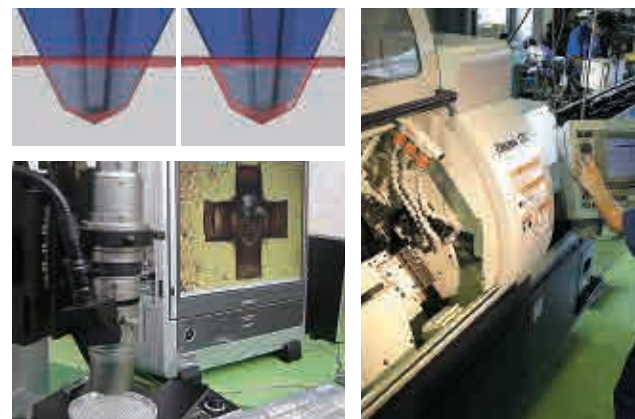

Reducing screw fastening cost

Cost Reduction!

To avoid a broken bit tip stuck in a screw head

VoHA
VESSEL Outstanding High-Performance Alloy
World Toughest VoHA steel material
Highest Durability Bit was born

To avoid a stripping screw head

Tip Toughness Test

Torsion force is increased until failure and to show the highest torque value.

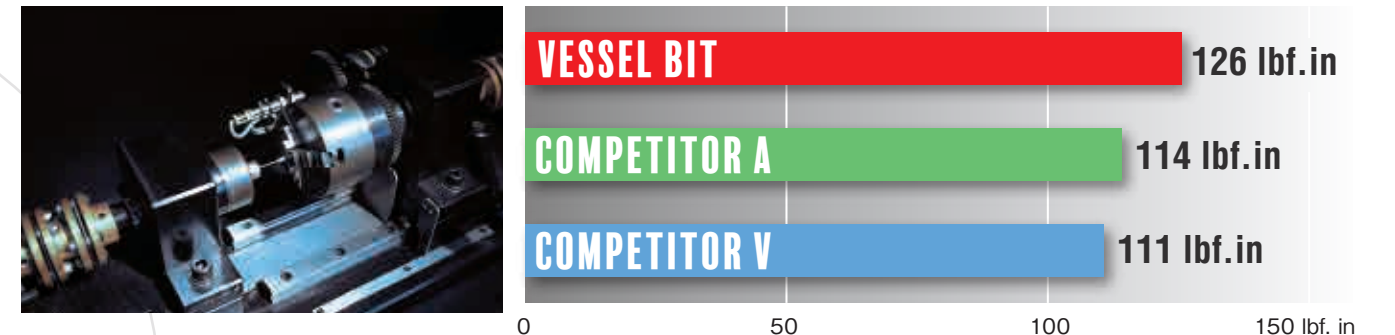

Reduces the amount of waste

Products due to screw

Precision Fitting

Screwdriver bits are produced with less variation by improvement of machining accuracy with superior machines and thorough quality control. The tip profile is thoroughly analyzed for fitting well with screws using a 3D digitizer.

Ideal fitting not only prevents stripping a screw head but also improves the durability of screwdriver bit.



Selecting Phillips tip according to hardness classification

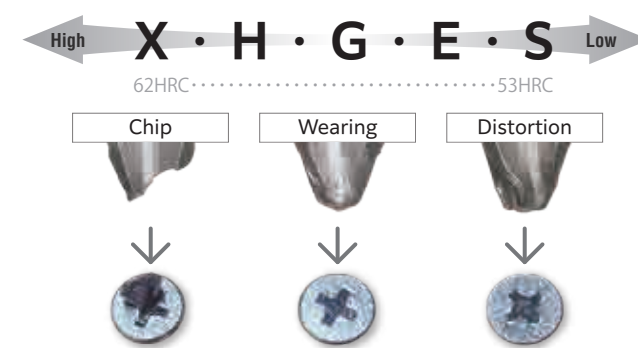

Easy to fracture when a bit is higher than optimum hardness
Easy to wear-out or distort when a bit is lower than optimum hardness

Mag Applied Technology

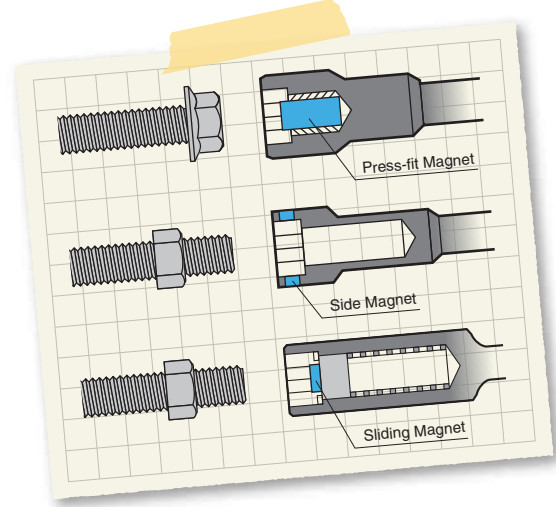
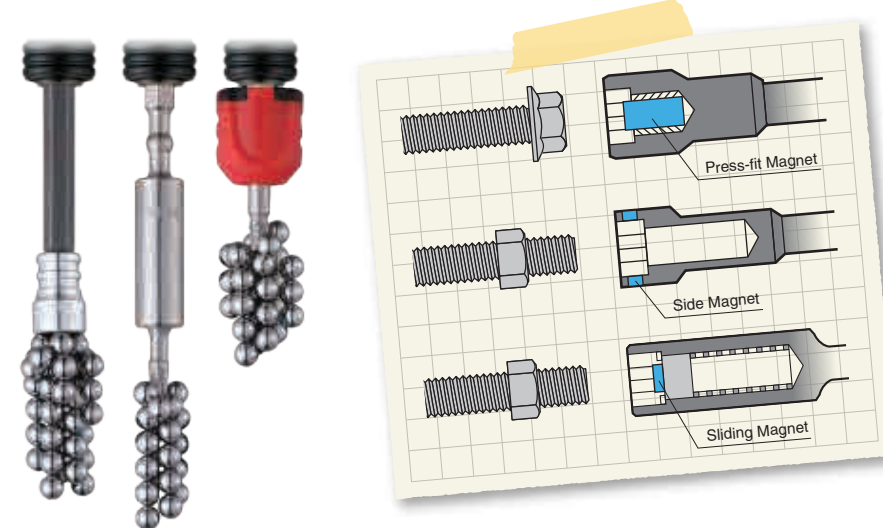

Hold a screw with strong magnetic force. Magnet applied technology is a significantly effective tools for the prevention of screw fall-off during work. A wide variety of products are offered depending upon each work application.

Insert Bits



NECK TORSION

It absorbs and reduces vibration occurred during screwing into tree knots, tapping, and such application. It suppresses bounce of a bit itself and can be expected improvement of work efficiency and long life of a bit.

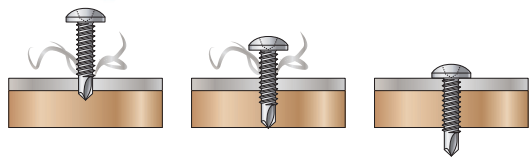

Drive : 1/4 DIN 3126-C6.3, ISO 1173  H 6.35mm

1/4" Hex NECK TORSION™ Insert Bit

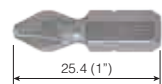

| Model No. | Tip Size | Overall Length | Hardness | Inner Ctn. | Code |
|--------------|----------|----------------|----------|-------------|--------|
| NTPH1254P3 | PH1 | 25.4 | X | 3PC/Carded | 426001 |
| NTPH2254P3 | PH2 | 25.4 | X | 3PC/Carded | 426002 |
| NTPH3254P3 | PH3 | 25.4 | X | 3PC/Carded | 426003 |
| NTPH2254P5 | PH2 | 25.4 | X | 5PC/Carded | 426004 |
| NTPH2254P25T | PH2 | 25.4 | X | 25PC/TicTac | 426041 |
| NTPH1254P25K | PH1 | 25.4 | X | 25 | 426042 |
| NTPH2254P25K | PH2 | 25.4 | X | 25 | 426043 |
| NTPH3254P25K | PH3 | 25.4 | X | 25 | 426044 |

1/4" Hex NECK TORSION™ Insert Bit



| Model No. | Tip Size | Overall Length | Hardness | Inner Ctn. | Code |
|---------------|----------|----------------|----------|------------|--------|
| NTTX15254P3 | T15 | 25.4 | X | 3PC/Carded | 426005 |
| NTTX20254P3 | T20 | 25.4 | X | 3PC/Carded | 426006 |
| NTTX25254P3 | T25 | 25.4 | X | 3PC/Carded | 426007 |
| NTTX10254P25K | T10 | 25.4 | X | 25 | 426045 |
| NTTX15254P25K | T15 | 25.4 | X | 25 | 426046 |
| NTTX20254P25K | T20 | 25.4 | X | 25 | 426047 |
| NTTX25254P25K | T25 | 25.4 | X | 25 | 426048 |
| NTTX30254P25K | T30 | 25.4 | X | 25 | 426049 |

1/4" Hex NECK TORSION™ Insert Bit



| Model No. | Tip Size | Overall Length | Hardness | Inner Ctn. | Code |
|--------------|----------|----------------|----------|------------|--------|
| NTSQ1254P3 | SQ1 | 25.4 | X | 3PC/Carded | 426008 |
| NTSQ2254P3 | SQ2 | 25.4 | X | 3PC/Carded | 426009 |
| NTSQ3254P3 | SQ3 | 25.4 | X | 3PC/Carded | 426010 |
| NTSQ1254P25K | SQ1 | 25.4 | X | 25 | 426050 |
| NTSQ2254P25K | SQ2 | 25.4 | X | 25 | 426051 |
| NTSQ3254P25K | SQ3 | 25.4 | X | 25 | 426052 |

1/4" Hex Insert Bit



| Model No. | Tip Size | Overall Length | Hardness | Inner Ctn. | Code |
|-------------|----------|----------------|----------|------------|--------|
| B33P03254H | PH0 | 25.4 | H | 10 | 426124 |
| B33P1254H | PH1 | 25.4 | H | 10 | 421231 |
| B33P145254H | PH1 | 25.4 | H | 10 | 426120 |
| B33P2254H | PH2 | 25.4 | H | 10 | 421241 |
| B33P25254H | PH2 | 25.4 | H | 10 | 426125 |
| B33P3254G | PH3 | 25.4 | G | 10 | 421242 |

1/4" Hex Insert Bit



| Model No. | Tip Width/ Shank Diameter | Overall Length | Hardness | Inner Ctn. | Code |
|-----------|---------------------------|----------------|----------|------------|--------|
| B33S4254G | 4 | 25.4 | G | 10 | 421251 |
| B33S6254G | 6 | 25.4 | G | 10 | 421252 |

1/4" Hex Insert Bit



| Model No. | Tip Size | Overall Length | Hardness | Inner Ctn. | Code |
|------------|----------|----------------|----------|------------|--------|
| B33H2254H | H2 | 25.4 | H | 10 | 421260 |
| B33H25254H | H2.5 | 25.4 | H | 10 | 421261 |
| B33H3254H | H3 | 25.4 | H | 10 | 421262 |
| B33H4333H | H4 | 33 | H | 10 | 421263 |
| B33H5333H | H5 | 33 | H | 10 | 421264 |
| B33H6333H | H6 | 33 | H | 10 | 421265 |

1/4" Hex Insert Bit

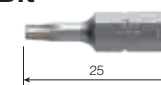

| Model No. | Tip Size | Overall Length | Inner Ctn. | Code |
|------------|----------|----------------|------------|--------|
| B33T325H | T3 | 25 | 10 | 489154 |
| B33T525H | T5 | 25 | 10 | 489155 |
| B33T6254H | T6 | 25.4 | 10 | 635400 |
| B33T725H | T7 | 25 | 10 | 489157 |
| B33T8254H | T8 | 25.4 | 10 | 635401 |
| B33T10254H | T10 | 25.4 | 10 | 635402 |
| B33T15254H | T15 | 25.4 | 10 | 635403 |
| B33T20254H | T20 | 25.4 | 10 | 635404 |
| B33T25254H | T25 | 25.4 | 10 | 635405 |
| B33T27254H | T27 | 25.4 | 10 | 635406 |
| B33T30254H | T30 | 25.4 | 10 | 635407 |
| B33T40254H | T40 | 25.4 | 10 | 635408 |

1/4" Hex Insert Bit



| Model No. | Tip Size | Overall Length | Hardness | Inner Ctn. | Code |
|------------|----------|----------------|----------|------------|--------|
| B33IP1525H | 15IP | 25 | H | 10 | 447204 |
| B33IP2025H | 20IP | 25 | H | 10 | 447205 |
| B33IP2525H | 25IP | 25 | H | 10 | 447206 |
| B33IP3025H | 30IP | 25 | H | 10 | 447207 |
| B33IP4025H | 40IP | 25 | H | 10 | 447208 |

Drive : 5/16 DIN 3126-C8, ISO 1173  H 8 mm

5/16" Hex Insert Bit



| Model No. | Tip Size | Overall Length | Inner Ctn. | Code |
|-----------|----------|----------------|------------|--------|
| A5T3032H | T30 | 32 | 10 | 635427 |
| A5T4032H | T40 | 32 | 10 | 635428 |
| A5T4532H | T45 | 32 | 10 | 635429 |
| A5T5032H | T50 | 32 | 10 | 635430 |

Drive : 1/4 DIN 3126-C6.3, ISO 1173  H 6.35 mm

Magnet Screw Catcher

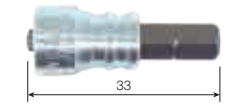

| Model No. | Tip Size | Overall Length | Inner Ctn. | Code |
|--------------|----------|----------------|------------|--------|
| B33MMBCP133H | PH1 | 33 | 10 | 447105 |
| B33MMBCP233H | PH2 | 33 | 10 | 447106 |

Magnet Screw Catcher

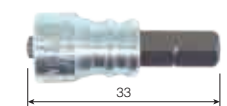

| Model No. | Tip Size | Overall Length | Inner Ctn. | Code |
|---------------|----------|----------------|------------|--------|
| B33MMBCPZ133H | PZ1 | 33 | 10 | 447107 |
| B33MMBCPZ233H | PZ2 | 33 | 10 | 447108 |

Magnet Screw Catcher

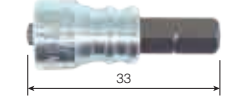

| Model No. | Tip Size | Overall Length | Inner Ctn. | Code |
|---------------|----------|----------------|------------|--------|
| B33MMBCT1033H | T10 | 33 | 10 | 447104 |
| B33MMBCT1533H | T15 | 33 | 10 | 447102 |
| B33MMBCT2033H | T20 | 33 | 10 | 447103 |
| B33MMBCT2533H | T25 | 33 | 10 | 447110 |

Replacement Bits For MMBC Series

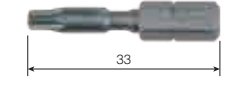

| Model No. | Tip Size | Overall Length | Inner Ctn. | Code |
|-----------------|----------|----------------|------------|--------|
| B33MMBCT1033HRB | T10 | 33 | 10 | 447329 |
| B33MMBCT1533HRB | T15 | 33 | 10 | 447330 |
| B33MMBCT2033HRB | T20 | 33 | 10 | 447331 |
| B33MMBCT2533HRB | T25 | 33 | 10 | 447332 |
| B33MMBCP133HRB | PH1 | 33 | 10 | 447333 |
| B33MMBCP233HRB | PH2 | 33 | 10 | 447334 |
| B33MMBCPZ133HRB | PZ1 | 33 | 10 | 447335 |
| B33MMBCPZ233HRB | PZ2 | 33 | 10 | 447336 |

Power Bits

Drive : 1/4 DIN 3126-E6.3, ISO 1173

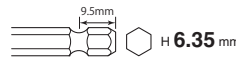

1/4" Hex NECK TORSION™ Power Bit

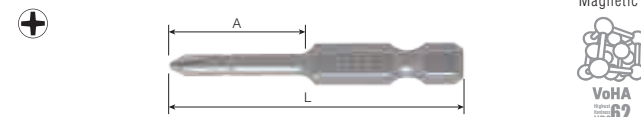

| Model No. | Tip Size | Overall Length | Length (A) | Hardness | Inner Ctn. | Code |
|--------------|----------|----------------|------------|----------|-------------|--------|
| NTPH150P2 | PH1 | 50 | 25 | X | 2PC/Carded | 426017 |
| NTPH250P2 | PH2 | 50 | 25 | X | 2PC/Carded | 426018 |
| NTPH350P2 | PH3 | 50 | 25 | X | 2PC/Carded | 426021 |
| NTPH250P5 | PH2 | 50 | 25 | X | 5PC/Carded | 426022 |
| NTPH250P15T | PH2 | 50 | 25 | X | 15PC/TicTac | 426029 |
| NTPH150P25K | PH1 | 50 | 25 | X | 25 | 426053 |
| NTPH250P25K | PH2 | 50 | 25 | X | 25 | 426054 |
| NTPH350P25K | PH3 | 50 | 25 | X | 25 | 426055 |
| NTPH275P2 | PH2 | 75 | 25 | X | 2PC/Carded | 426019 |
| NTPH275P10K | PH2 | 75 | 25 | X | 10 | 426062 |
| NTPH2150P1 | PH2 | 150 | 100 | X | 1PC/Carded | 426020 |
| NTPH2150P10K | PH2 | 150 | 100 | X | 10 | 426063 |

1/4" Hex NECK TORSION™ Power Bit

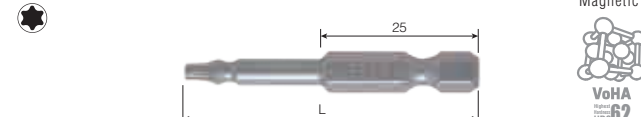

| Model No. | Tip Size | Overall Length | Hardness | Inner Ctn. | Code |
|--------------|----------|----------------|----------|------------|--------|
| NTTX1550P2 | T15 | 50 | X | 2PC/Carded | 426023 |
| NTTX2050P2 | T20 | 50 | X | 2PC/Carded | 426024 |
| NTTX2550P2 | T25 | 50 | X | 2PC/Carded | 426025 |
| NTTX1550P25K | T15 | 50 | X | 25 | 426056 |
| NTTX2050P25K | T20 | 50 | X | 25 | 426057 |
| NTTX2550P25K | T25 | 50 | X | 25 | 426058 |

1/4" Hex NECK TORSION™ Power Bit

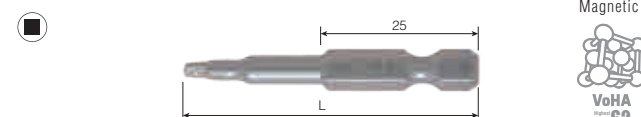

| Model No. | Tip Size | Overall Length | Hardness | Inner Ctn. | Code |
|-------------|----------|----------------|----------|------------|--------|
| NTSQ150P2 | SQ1 | 50 | X | 2PC/Carded | 426026 |
| NTSQ250P2 | SQ2 | 50 | X | 2PC/Carded | 426027 |
| NTSQ350P2 | SQ3 | 50 | X | 2PC/Carded | 426028 |
| NTSQ150P25K | SQ1 | 50 | X | 25 | 426059 |
| NTSQ250P25K | SQ2 | 50 | X | 25 | 426060 |
| NTSQ350P25K | SQ3 | 50 | X | 25 | 426061 |

1/4" Hex Power BIT



| Model No. | Tip Size | Overall Length | Hardness | Body Diameter | Inner Ctn. | Code |
|---------------|----------|----------------|----------|---------------|------------|--------|
| B35P00122060H | PH00 | 60 | H | 1.2 | 10 | 446126 |
| B35P0015849H | PH00 | 49 | H | 1.58 | 10 | 446423 |
| B35P00240100H | PH00 | 100 | H | 2.0 | 10 | 446141 |
| B35P031749H | PH0 | 49 | H | 3.17 | 10 | 487195 |
| B35P0143060H | PH0 | 60 | H | 1.4 | 10 | 446145 |
| B35P022060H | PH0 | 60 | H | 2.0 | 10 | 446153 |
| B35P0230100H | PH0 | 100 | H | 2.0 | 10 | 446157 |
| B35P150H | PH1 | 50 | H | 7 | 10 | 424032 |
| B35P175H | PH1 | 75 | H | 7 | 10 | 424035 |
| B35P145100H | PH1 | 100 | H | 4.5 | 10 | 424036 |
| B35P14889H | PH1 | 89 | H | 4.8 | 10 | 487202 |
| B35P248100H | PH2 | 100 | H | 4.8 | 10 | 446429 |
| B35P26100H | PH2 | 100 | H | 6 | 10 | 489255 |
| B35P26150H | PH2 | 150 | H | 6 | 10 | 489673 |
| B35P26200H | PH2 | 200 | H | 6 | 10 | 446439 |
| B35P263549H | PH2 | 49 | H | 6.4 | 10 | 487205 |
| B35P263570H | PH2 | 70 | H | 6.35 | 10 | 487206 |
| B35P263589H | PH2 | 89 | H | 6.35 | 10 | 487207 |
| B35P2635152H | PH2 | 152 | H | 6.35 | 10 | 487208 |
| B35P250X | PH2 | 50 | X | 7 | 10 | 424061 |
| B35P250G | PH2 | 50 | G | 7 | 10 | 424040 |
| B35P275X | PH2 | 75 | X | 7 | 10 | 424062 |
| B35P275H | PH2 | 75 | H | 7 | 10 | 424047 |
| B35P275G | PH2 | 75 | G | 7 | 10 | 424041 |
| B35P275E | PH2 | 75 | E | 7 | 10 | 424042 |
| B35P2775100H | PH2 | 100 | H | 7 | 10 | 424048 |
| B35P2100G | PH2 | 100 | G | 7 | 10 | 424043 |
| B35P2100E | PH2 | 100 | E | 7 | 10 | 424044 |
| B35P2150H | PH2 | 150 | H | 7 | 10 | 424049 |
| B35P2150G | PH2 | 150 | G | 7 | 10 | 424045 |
| B35P2150E | PH2 | 150 | E | 7 | 10 | 424046 |
| B35P245100H | PH2 | 100 | H | 4.5 | 10 | 424038 |
| B35P349H | PH3 | 49 | H | 7.9 | 10 | 487210 |
| B35P389H | PH3 | 89 | H | 7.9 | 10 | 487212 |
| B35P375H | PH3 | 75 | H | 7 | 10 | 424050 |
| B35P375E | PH3 | 75 | E | 7 | 10 | 424051 |
| B35P3100H | PH3 | 100 | H | 7 | 10 | 424052 |
| B35P3100E | PH3 | 100 | E | 7 | 10 | 424053 |
| B35P3150G | PH3 | 150 | G | 7 | 10 | 424054 |

1/4" Hex Power BIT



| Model No. | Overall Length | Hardness | Tip Width/ Shank Diameter | Inner Ctn. | Code |
|--------------|----------------|----------|---------------------------|------------|--------|
| B35S675E | 75 | E | 6 | 10 | 424075 |
| B35S6351049H | 49 | H | 6.35 | 10 | 487245 |
| B35S791249H | 49 | H | 7.9 | 10 | 487255 |

1/4" Hex Power BIT

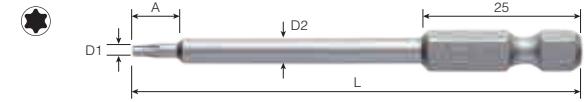

| Model No. | Tip Size | Overall Length | Length (A) | Body Diameter(D1) | Body Diameter(D2) | Inner Ctn. | Code |
|------------|----------|----------------|------------|-------------------|-------------------|------------|--------|
| B35T549H | T5 | 49 | 6.5 | 1.67 | 3.18 | 10 | 446486 |
| B35T570H | T5 | 70 | 6.5 | 1.67 | 3.18 | 10 | 447355 |
| B35T589H | T5 | 89 | 6.5 | 1.67 | 3.18 | 10 | 447356 |
| B35T675H | T6 | 75 | 6.5 | 1.95 | 3.96 | 10 | 635300 |
| B35T6100H | T6 | 100 | 6.5 | 1.95 | 3.96 | 10 | 635301 |
| B35T6152H | T6 | 152 | 6.5 | 1.95 | 3.18 | 10 | 447317 |
| B35T770H | T7 | 70 | 6.5 | 2.27 | 3.18 | 10 | 446499 |
| B35T775H | T7 | 75 | 6.5 | 2.27 | 4 | 10 | 635303 |
| B35T790H | T7 | 90 | 6.5 | 2.27 | 3.18 | 10 | 446509 |
| B35T7152H | T7 | 152 | 6.5 | 2.27 | 3.18 | 10 | 446519 |
| B35T849H | T8 | 49 | 7.0 | 2.6 | 3.18 | 10 | 446489 |
| B35T870H | T8 | 70 | 7.0 | 2.6 | 3.18 | 10 | 446500 |
| B35T875H | T8 | 75 | 7.0 | 2.6 | 4.5 | 10 | 635305 |
| B35T890H | T8 | 90 | 7.0 | 2.6 | 3.18 | 10 | 446510 |
| B35T8100H | T8 | 100 | 7.0 | 2.6 | 4.5 | 10 | 635306 |
| B35T8152H | T8 | 152 | 7.0 | 2.6 | 3.18 | 10 | 446520 |
| B35T970H | T9 | 70 | 7.0 | 2.78 | 3.18 | 10 | 446501 |
| B35T990H | T9 | 90 | 7.0 | 2.78 | 3.18 | 10 | 446511 |
| B35T9152H | T9 | 152 | 7.0 | 2.78 | 3.18 | 10 | 446521 |
| B35T1049H | T10 | 49 | 7.5 | 3.02 | 3.96 | 10 | 446491 |
| B35T1070H | T10 | 70 | 7.5 | 3.02 | 3.96 | 10 | 446502 |
| B35T1075H | T10 | 75 | 7.5 | 3.02 | 4.5 | 10 | 635310 |
| B35T10100H | T10 | 100 | 7.5 | 3.02 | 4.5 | 10 | 635311 |
| B35T10152H | T10 | 152 | 7.5 | 3.02 | 3.96 | 10 | 446522 |
| B35T1549H | T15 | 49 | 7.5 | 3.56 | 3.96 | 10 | 446492 |
| B35T1570H | T15 | 70 | 7.5 | 3.56 | 3.96 | 10 | 446503 |
| B35T1575H | T15 | 75 | 7.5 | 3.56 | 4.5 | 10 | 635315 |
| B35T1590H | T15 | 90 | 7.5 | 3.56 | 3.96 | 10 | 446513 |
| B35T15100H | T15 | 100 | 7.5 | 3.56 | 4.5 | 10 | 635316 |
| B35T15152H | T15 | 152 | 7.5 | 3.56 | 3.96 | 10 | 446523 |
| B35T2049H | T20 | 49 | 4.75 | 4.14 | 4.75 | 10 | 446493 |
| B35T2070H | T20 | 70 | 4.75 | 4.14 | 4.75 | 10 | 446504 |
| B35T2075H | T20 | 75 | 7.5 | 4.14 | 5 | 10 | 635320 |
| B35T20100H | T20 | 100 | 7.5 | 4.14 | 5 | 10 | 635321 |
| B35T20152H | T20 | 152 | 7.5 | 4.14 | 4.37 | 10 | 446524 |
| B35T2570H | T25 | 70 | 8.0 | 4.7 | 5 | 10 | 446505 |
| B35T2575H | T25 | 75 | 8.0 | 4.7 | 5 | 10 | 635325 |
| B35T25100H | T25 | 100 | 8.0 | 4.7 | 5 | 10 | 635326 |
| B35T25152H | T25 | 152 | 8.0 | 4.7 | 4.75 | 10 | 446525 |
| B35T2775H | T27 | 75 | 8.0 | 5.26 | 5.5 | 10 | 635330 |
| B35T27100H | T27 | 100 | 8.0 | 5.26 | 5.5 | 10 | 635331 |
| B35T27152H | T27 | 152 | 8.0 | 5.26 | 6.4 | 10 | 446526 |
| B35T3070H | T30 | 70 | 8.5 | 5.79 | 6.4 | 10 | 446507 |
| B35T3075H | T30 | 75 | 8.5 | 5.79 | 6 | 10 | 635335 |
| B35T3090H | T30 | 90 | 8.5 | 5.79 | 6.4 | 10 | 446517 |
| B35T30100H | T30 | 100 | 8.5 | 5.79 | 6 | 10 | 635336 |
| B35T30152H | T30 | 152 | 8.5 | 5.79 | 6.4 | 10 | 446527 |
| B35T4049H | T40 | 49 | - | - | 7 | 10 | 446497 |
| B35T4070H | T40 | 70 | - | - | 8 | 10 | 446508 |
| B35T4075H | T40 | 75 | - | - | 8 | 10 | 635340 |
| B35T4090H | T40 | 90 | - | - | 8 | 10 | 446518 |
| B35T40100H | T40 | 100 | - | - | 7 | 10 | 635341 |

| Model No. | Tip Size | Overall Length | Length (A) | Body Diameter(D1) | Body Diameter(D2) | Inner Ctn. | Code |
|------------|----------|----------------|------------|-------------------|-------------------|------------|--------|
| B35T40152H | T40 | 152 | - | - | 8 | 10 | 446528 |
| B35T4575H | T45 | 75 | - | - | 7.9 | 10 | 635345 |
| B35T45100H | T45 | 100 | - | - | 7.9 | 10 | 635346 |

1/4" Hex Power BIT

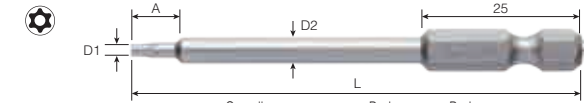

| Model No. | Tip Size | Overall Length | Length (A) | Body Diameter(D1) | Body Diameter(D2) | Inner Ctn. | Code |
|-------------|----------|----------------|------------|-------------------|-------------------|------------|--------|
| B35T6H75H | T6H | 75 | 6.5 | 1.95 | 3.96 | 10 | 635283 |
| B35T6H100H | T6H | 100 | 6.5 | 1.95 | 3.96 | 10 | 635284 |
| B35T8H75H | T8H | 75 | 7.0 | 2.60 | 4.5 | 10 | 635285 |
| B35T8H100H | T8H | 100 | 7.0 | 2.60 | 4.5 | 10 | 635286 |
| B35T10H49H | T10H | 49 | 7.5 | 3.02 | 3.96 | 10 | 446533 |
| B35T10H70H | T10H | 70 | 7.5 | 3.02 | 3.96 | 10 | 446544 |
| B35T10H75H | T10H | 75 | 7.5 | 3.02 | 4.5 | 10 | 635251 |
| B35T10H100H | T10H | 100 | 7.5 | 3.02 | 4.5 | 10 | 635252 |
| B35T15H75H | T15H | 75 | 7.5 | 3.56 | 4.5 | 10 | 635255 |
| B35T15H100H | T15H | 100 | 7.5 | 3.56 | 4.5 | 10 | 635256 |
| B35T20H49H | T20H | 49 | 7.5 | 4.14 | 4.37 | 10 | 446535 |
| B35T20H70H | T20H | 70 | 7.5 | 4.14 | 4.37 | 10 | 446546 |
| B35T20H75H | T20H | 75 | 7.5 | 4.14 | 5 | 10 | 635261 |
| B35T20H100H | T20H | 100 | 7.5 | 4.14 | 5 | 10 | 635262 |
| B35T25H75H | T25H | 75 | 8.0 | 4.70 | 5 | 10 | 635265 |
| B35T25H100H | T25H | 100 | 8.0 | 4.70 | 5 | 10 | 635266 |
| B35T27H75H | T27H | 75 | 8.0 | 5.26 | 5.5 | 10 | 635271 |
| B35T27H100H | T27H | 100 | 8.0 | 5.26 | 5.5 | 10 | 635272 |
| B35T30H75H | T30H | 75 | 8.5 | 5.79 | 6 | 10 | 635275 |
| B35T30H100H | T30H | 100 | 8.5 | 5.79 | 6 | 10 | 635276 |
| B35T40H75H | T40H | 75 | - | - | 7 | 10 | 635281 |
| B35T40H100H | T40H | 100 | - | - | 7 | 10 | 635282 |

1/4" Hex Power BIT



| Model No. | Tip Size | Overall Length | Length (A) | Body Diameter(D1) | Body Diameter(D2) | Hardness | Inner Ctn. | Code |
|-----------|----------|----------------|------------|-------------------|-------------------|----------|------------|--------|
| B35H275H | H2 | 75 | 9.5 | 2.35 | 7 | H | 10 | 424080 |
| B35H2100H | H2 | 100 | 9.5 | 2.35 | 7 | H | 10 | 424081 |
| B35H2575H | H2.5 | 75 | 9.5 | 2.9 | 7 | H | 10 | 424082 |

Power Bits/ Mag Catcher

Drive : 1/4 DIN 3126-E6.3, ISO 1173  H 6.35mm

1/4" Hex Power BIT

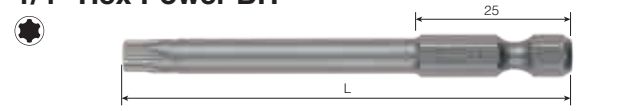

| Model No. | Tip Size | Overall Length | Hardness | Body Diameter | Inner Ctn. | Code |
|-------------|----------|----------------|----------|---------------|------------|--------|
| B35IP6152H | 6IP | 152 | H | 1.64 | 10 | 447251 |
| B35IP7152H | 7IP | 152 | H | 1.99 | 10 | 447252 |
| B35IP8152H | 8IP | 152 | H | 2.31 | 10 | 447253 |
| B35IP949H | 9IP | 49 | H | 2.5 | 10 | 447229 |
| B35IP970H | 9IP | 70 | H | 2.5 | 10 | 447236 |
| B35IP990H | 9IP | 90 | H | 2.5 | 10 | 447243 |
| B35IP9152H | 9IP | 152 | H | 2.5 | 10 | 447226 |
| B35IP1090H | 10IP | 90 | H | 2.74 | 10 | 447244 |
| B35IP10152H | 10IP | 152 | H | 2.74 | 10 | 447254 |
| B35IP1549H | 15IP | 49 | H | 3.27 | 10 | 447230 |
| B35IP1570H | 15IP | 70 | H | 3.27 | 10 | 447237 |
| B35IP1590H | 15IP | 90 | H | 3.27 | 10 | 447245 |
| B35IP15152H | 15IP | 152 | H | 3.27 | 10 | 447255 |
| B35IP2049H | 20IP | 49 | H | 3.86 | 10 | 447231 |
| B35IP2070H | 20IP | 70 | H | 3.86 | 10 | 447238 |
| B35IP2090H | 20IP | 90 | H | 3.86 | 10 | 447246 |
| B35IP20152H | 20IP | 152 | H | 3.86 | 10 | 447256 |
| B35IP2549H | 25IP | 49 | H | 4.43 | 10 | 447232 |
| B35IP2570H | 25IP | 70 | H | 4.43 | 10 | 447239 |
| B35IP2590H | 25IP | 90 | H | 4.43 | 10 | 447247 |
| B35IP25152H | 25IP | 152 | H | 4.43 | 10 | 447257 |
| B35IP3049H | 30IP | 49 | H | 5.52 | 10 | 447234 |
| B35IP3070H | 30IP | 70 | H | 5.52 | 10 | 447241 |
| B35IP3090H | 30IP | 90 | H | 5.52 | 10 | 447249 |
| B35IP30152H | 30IP | 152 | H | 5.52 | 10 | 447259 |
| B35IP4049H | 40IP | 49 | H | 6.65 | 10 | 447235 |
| B35IP4070H | 40IP | 70 | H | 6.65 | 10 | 447242 |
| B35IP4090H | 40IP | 90 | H | 6.65 | 10 | 447250 |
| B35IP40152H | 40IP | 152 | H | 6.65 | 10 | 447260 |

1/4" Hex Power BIT



| Model No. | Tip Size | Overall Length | Hardness | Inner Ctn. | Code |
|-----------|----------|----------------|----------|------------|--------|
| B35P123H | PH1 | 23 | H | 10 | 424131 |
| B35P223H | PH2 | 23 | H | 10 | 424141 |
| B35P240H | PH2 | 40 | H | 10 | 424143 |
| B35P2100H | PH2 | 100 | H | 10 | 424147 |

1/4" Hex Power BIT

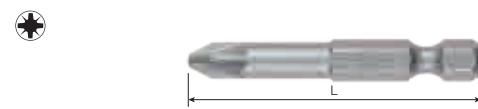

| Model No. | Tip Size | Overall Length | Hardness | Body Diameter | Inner Ctn. | Code |
|-------------|----------|----------------|----------|---------------|------------|--------|
| B35PZ14850H | PZ1 | 50 | 4.8 | H | 10 | 424101 |
| B35PZ26350H | PZ2 | 50 | 6.3 | H | 10 | 424102 |
| B35PZ3850H | PZ3 | 50 | 8 | H | 10 | 424103 |

1/4" Hex Power BIT



| Model No. | Tip Size | Overall Length | Hardness | Inner Ctn. | Code |
|-----------|----------|----------------|----------|------------|--------|
| B35TW140H | TW1 | 40 | H | 10 | 424201 |
| B35TW240H | TW2 | 40 | H | 10 | 424202 |
| B35TW340H | TW3 | 40 | H | 10 | 424203 |
| B35TW440H | TW4 | 40 | H | 10 | 424204 |

1/4" Hex NECK TORSION™ Mag Catcher Power Bit



| Model No. | Tip Size | Overall Length | Inner Ctn. | Code |
|----------------|----------|----------------|------------|--------|
| B35MMBCT1049H | T10 | 49 | 10 | 447111 |
| B35MMBCT1070H | T10 | 70 | 10 | 447112 |
| B35MMBCT1549H | T15 | 49 | 10 | 447115 |
| B35MMBCT1570H | T15 | 70 | 10 | 447116 |
| B35MMBCT2049H | T20 | 49 | 10 | 447113 |
| B35MMBCT2075H | T20 | 75 | 10 | 447101 |
| B35MMBCT20150H | T20 | 150 | 10 | 447109 |
| B35MMBCT2549H | T25 | 49 | 10 | 447117 |
| B35MMBCT2570H | T25 | 70 | 10 | 447118 |

1/4" Hex NECK TORSION™ Mag Catcher Insert Bit Replacement Bit



| Model No. | Tip Size | Overall Length | Inner Ctn. | Code |
|------------------|----------|----------------|------------|--------|
| B35MMBCT1049HRB | T10 | 49 | 10 | 447337 |
| B35MMBCT1070HRB | T10 | 70 | 10 | 447338 |
| B35MMBCT1549HRB | T15 | 49 | 10 | 447361 |
| B35MMBCT1570HRB | T15 | 70 | 10 | 447362 |
| B35MMBCT2049HRB | T20 | 49 | 10 | 447339 |
| B35MMBCT2075HRB | T20 | 75 | 10 | 447340 |
| B35MMBCT20150HRB | T20 | 150 | 10 | 447341 |

1/4" Hex Power Bit Reduced Shaft

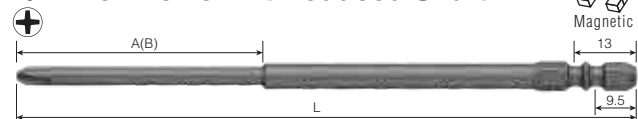

| Model No. | Tip Size | Overall Length | Length (A/B) | Hardness | Body Diameter | Inner Ctn. | Code |
|---------------|----------|----------------|--------------|----------|---------------|------------|--------|
| MAB16P24565H | PH2 | 65 | 40 | H | 4.5 | 10 | 415301 |
| MAB16P245100H | PH2 | 100 | 75 | H | 4.5 | 10 | 415302 |
| MAB16P245150H | PH2 | 150 | 50(75) | H | 4.5 | 10 | 415303 |

MAGNETIC SCREW CATCHER



| Model No. | Overall Length | Inner Ctn. | Code |
|------------|----------------|------------|--------|
| MBCAF63571 | 71 | 1PC | 486345 |

Double-Ended Power Bits

Drive : 1/4 DIN 3126-E6.3, ISO 1173  H 6.35mm

1/4" Hex Double-Ended Power BIT



| Model No. | Tip Size | Overall Length | Hardness | Inner Ctn. | Code |
|-----------|----------|----------------|----------|------------|--------|
| B43P175H | PH1 | 75 | H | 10 | 425032 |
| B43P250X | PH2 | 50 | X | 10 | 425036 |
| B43P250H | PH2 | 50 | H | 10 | 425037 |
| B43P250E | PH2 | 50 | E | 10 | 425038 |
| B43P275X | PH2 | 75 | X | 10 | 425039 |
| B43P275H | PH2 | 75 | H | 10 | 425040 |
| B43P275G | PH2 | 75 | G | 10 | 425041 |
| B43P275E | PH2 | 75 | E | 10 | 425042 |
| B43P2100X | PH2 | 100 | X | 10 | 425046 |
| B43P2100H | PH2 | 100 | H | 10 | 425047 |
| B43P2100G | PH2 | 100 | G | 10 | 425043 |
| B43P2100E | PH2 | 100 | E | 10 | 425044 |
| B43P2150X | PH2 | 150 | X | 10 | 425048 |
| B43P2150H | PH2 | 150 | H | 10 | 425049 |
| B43P2150G | PH2 | 150 | G | 10 | 425045 |
| B43P2200G | PH2 | 200 | G | 10 | 425050 |
| B43P2300H | PH2 | 300 | H | 10 | 446373 |
| B43P375H | PH3 | 75 | H | 10 | 425054 |
| B43P375E | PH3 | 75 | E | 10 | 425055 |
| B43P3100H | PH3 | 100 | H | 10 | 425057 |
| B43P3100E | PH3 | 100 | E | 10 | 425058 |
| B43P3150H | PH3 | 150 | H | 10 | 446375 |

1/4" Hex Double-Ended Power BIT



| Model No. | Tip Size | Overall Length | Hardness | Inner Ctn. | Code |
|------------|----------|----------------|----------|------------|--------|
| MB43P275H | PH2 | 75 | H | 10 | 446669 |
| MB43P2100H | PH2 | 100 | H | 10 | 446672 |
| MB43P2150H | PH2 | 150 | H | 10 | 446673 |

1/4" Hex Double-Ended Power BIT



| Model No. | Tip Size | Overall Length | Hardness | Inner Ctn. | Code |
|------------|----------|----------------|----------|------------|--------|
| B43PP275H | PH2 | 75 | H | 10 | 425171 |
| B43PP2100H | PH2 | 100 | H | 10 | 425172 |

1/4" Hex Double-Ended Power BIT



| Model No. | Tip Size | Overall Length | Hardness | Inner Ctn. | Code |
|------------|----------|----------------|----------|------------|--------|
| B43HP275H | PH2 | 75 | H | 10 | 425151 |
| B43HP2100H | PH2 | 100 | H | 10 | 425153 |
| B43HP2150H | PH2 | 150 | H | 10 | 425155 |

1/4" Hex Double-Ended Power BIT



| Model No. | Tip Size | Overall Length | Hardness | Inner Ctn. | Code |
|------------|----------|----------------|----------|------------|--------|
| B43BP250S | PH2 | 50 | S | 10 | 425141 |
| B43BP275S | PH2 | 75 | S | 10 | 425142 |
| B43BP2100S | PH2 | 100 | S | 10 | 425143 |
| B43BP2150S | PH2 | 150 | S | 10 | 425144 |

1/4" Hex Double-Ended Power BIT

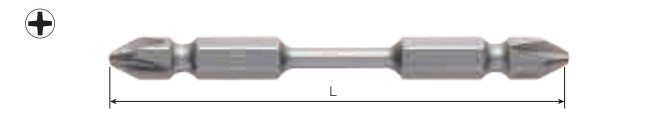

| Model No. | Tip Size | Overall Length | Hardness | Body Diameter | Inner Ctn. | Code |
|------------|----------|----------------|----------|---------------|------------|--------|
| BT43P275H | PH2 | 75 | H | Torsion | 10 | 425161 |
| BT43P2100H | PH2 | 100 | H | Torsion | 10 | 425162 |

1/4" Hex Double-Ended Power BIT

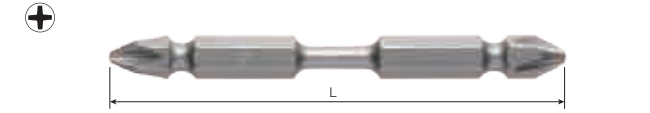

| Model No. | Tip Size | Overall Length | Hardness | Body Diameter | Inner Ctn. | Code |
|-------------|----------|----------------|----------|---------------|------------|--------|
| BT43PP275X | PH2 | 75 | X | Torsion | 10 | 425201 |
| BT43PP2100X | PH2 | 100 | X | Torsion | 10 | 425202 |

Selecting best fit Phillips tip* for various screw types

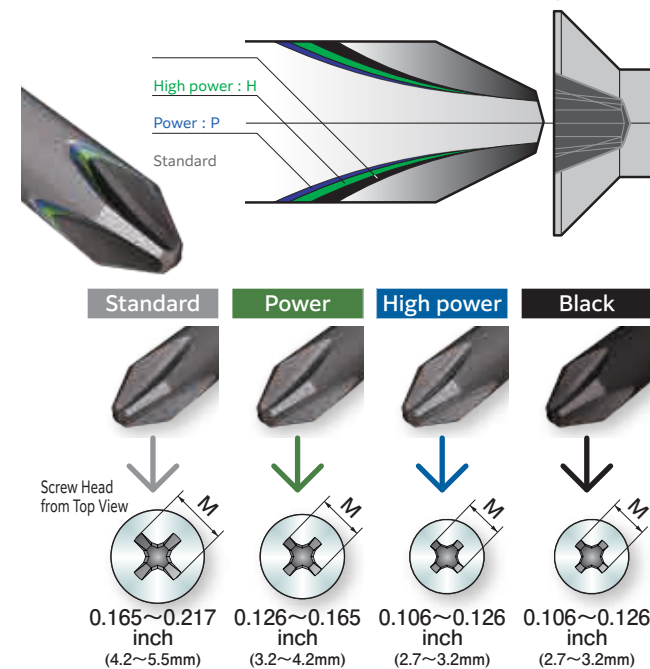

* M dimension : width across flats of screw recess from the top view
* Phillips is a registered trademark of Phillips Screw Co.

* All dimensions are in metric. Please contact us if you'd like to know it in imperial.

Nut Setters

220USB SERIES

MEGADORA SCREWDRIVER

BALL GRIP SCREWDRIVER

SUPER CUSHION SCREWDRIVER

WOOD COMPO SERIES

FOR ELECTRONICS TOOLS/ USEFUL TOOLS

DRIVER SET SERIES

OTHER HAND TOOLS

L-WRENCH

IMPACT BALL

NECK-TORSION

DRYWALLER/ QB

INSERT BITS

POWER BITS

POWER BITS/ MAG CATCHER

DOUBLE-ENDED POWER BITS

NUT SETTERS

Bit Holder

PRECISION BITS



Drive : 1/4 DIN 3126-C6.3, ISO 1173  H 6.35 mm

Nutsetter 1/4" Hex Nutsetter Metric

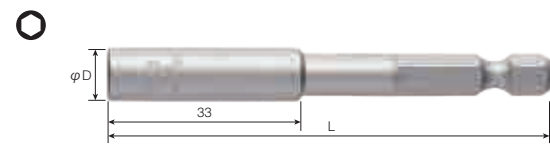

| Model No. | Socket Size | Overall Length | Socket Nose Diameter φ | Inner Ctn. | Code |
|-------------|-------------|----------------|------------------------|------------|----------|
| B45AF450 | A/F4 | 50 | 8 | 10 | 489301 |
| B45AF475 | A/F4 | 75 | 8 | 10 | 489314 |
| B45AF4100 | A/F4 | 100 | 8 | 10 | 489327 |
| B45AF4550 | AF/4.5 | 50 | 8 | 10 | 489302 |
| B45AF550 | AF/5 | 50 | 8 | 10 | 489303 |
| B45AF575 | AF/5 | 75 | 8 | 10 | 489316 |
| B45AF5100 | AF/5 | 100 | 8 | 10 | 489329 |
| B45AF5550 | A/F5.5 | 50 | 9 | 10 | 489304 |
| B45AF5575 | A/F5.5 | 75 | 9 | 10 | 424281 |
| B45AF55100 | A/F5.5 | 100 | 9 | 10 | 424380 |
| B45AF55150 | A/F5.5 | 150 | 9 | 10 | 424265 ☆ |
| B45AF650 | A/F6 | 50 | 10 | 10 | 489305 |
| B45AF675 | A/F6 | 75 | 10 | 10 | 424282 ☆ |
| B45AF6100 | A/F6 | 100 | 10 | 10 | 424381 |
| B45AF6150 | A/F6 | 150 | 10 | 10 | 424266 ☆ |
| B45AF750 | A/F7 | 50 | 13.5 | 10 | 489306 |
| B45AF71175 | A/F7 | 75 | 11 | 10 | 424279 |
| B45AF775 | A/F7 | 75 | 13.5 | 10 | 424283 ☆ |
| B45AF711100 | A/F7 | 100 | 11 | 10 | 424280 |
| B45AF7100 | A/F7 | 100 | 13.5 | 10 | 424382 ☆ |
| B45AF7150 | A/F7 | 150 | 13.5 | 10 | 424267 ☆ |
| B45AF850 | A/F8 | 50 | 13.5 | 10 | 489307 |
| B45AF875 | A/F8 | 75 | 13.5 | 10 | 424284 ☆ |
| B45AF8100 | A/F8 | 100 | 13.5 | 10 | 424383 ☆ |
| B45AF8150 | A/F8 | 150 | 13.5 | 10 | 424483 ☆ |
| B45AF950 | A/F9 | 50 | 16 | 10 | 489308 |
| B45AF1050 | A/F10 | 50 | 16 | 10 | 489309 |
| B45AF1075 | AF/10 | 75 | 16 | 10 | 424286 ☆ |
| B45AF10100 | AF/10 | 100 | 16 | 10 | 424384 ☆ |
| B45AF10150 | AF/10 | 150 | 16 | 10 | 424484 ☆ |
| B45AF1150 | A/F11 | 50 | 17 | 10 | 489310 |
| B45AF1175 | A/F11 | 75 | 17 | 10 | 424270 ☆ |
| B45AF11100 | A/F11 | 100 | 17 | 10 | 424271 ☆ |
| B45AF1250 | A/F12 | 50 | 18 | 10 | 489311 |
| B45AF1275 | A/F12 | 75 | 18 | 10 | 424287 ☆ |
| B45AF12100 | A/F12 | 100 | 18 | 10 | 424385 ☆ |
| B45AF12150 | A/F12 | 150 | 18 | 10 | 424272 ☆ |
| B45AF1350 | A/F13 | 50 | 19 | 10 | 489312 |
| B45AF1375 | AF/13 | 75 | 19 | 10 | 424288 ☆ |
| B45AF13100 | AF/13 | 100 | 19 | 10 | 424386 ☆ |
| B45AF1450 | A/F14 | 50 | 20 | 10 | 489313 |
| B45AF1475 | A/F14 | 75 | 20 | 10 | 424289 ☆ |
| B45AF14100 | A/F14 | 100 | 20 | 10 | 424387 ☆ |

☆ = Adopts a patented axial press-fit shank technique.

Nutsetter 1/4" Hex Magnet Nutsetter Metric

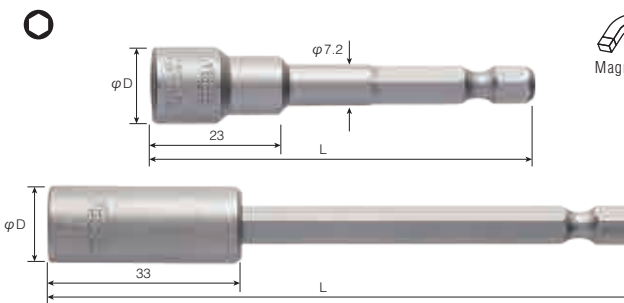

| Model No. | Socket Size | Overall Length | Socket Nose Diameter φ | Inner Ctn. | Code |
|-------------|-------------|----------------|------------------------|------------|----------|
| MB45AF550 | A/F5 | 50 | 8.5 | 10 | 489340 |
| MB45AF575 | A/F5 | 75 | 8.5 | 10 | 489351 |
| MB45AF5100 | A/F5 | 100 | 8.5 | 10 | 489362 |
| MB45AF5550 | A/F5.5 | 50 | 9 | 10 | 489341 |
| MB45AF5575 | A/F5.5 | 75 | 9 | 10 | 489352 |
| MB45AF650 | A/F6 | 50 | 10 | 10 | 489342 |
| MB45AF675 | A/F6 | 75 | 10 | 10 | 489353 |
| MB45AF6100 | A/F6 | 100 | 10 | 10 | 489364 |
| MB45AF750 | A/F7 | 50 | 13 | 10 | 489343 |
| MB45AF765 | A/F7 | 65 | 13 | 10 | 482520 |
| MB45AF775 | A/F7 | 75 | 13 | 10 | 489354 |
| MB45AF7100 | A/F7 | 100 | 13 | 10 | 489365 |
| MB45AF7150 | A/F7 | 150 | 13.5 | 10 | 446622 |
| MB45AF850 | A/F8 | 50 | 13.5 | 10 | 489344 |
| MB45AF865 | A/F8 | 65 | 13.5 | 10 | 482521 ☆ |
| MB45AF875 | A/F8 | 75 | 13.5 | 10 | 482523 |
| MB45AF8100 | A/F8 | 100 | 13.5 | 10 | 482524 ☆ |
| MB45AF8150 | A/F8 | 150 | 13.5 | 10 | 424274 ☆ |
| MB45AF950 | A/F9 | 50 | 14 | 10 | 489345 |
| MB45AF9665 | A/F9.6 | 65 | 15 | 10 | 482522 ☆ |
| MB45AF1050 | A/F10 | 50 | 16 | 10 | 489346 |
| MB45AF1075 | A/F10 | 75 | 16 | 10 | 482525 ☆ |
| MB45AF10100 | A/F10 | 100 | 16 | 10 | 482526 ☆ |
| MB45AF10150 | A/F10 | 150 | 16 | 10 | 424275 ☆ |
| MB45AF1150 | A/F11 | 50 | 17 | 10 | 489347 |
| MB45AF1175 | A/F11 | 75 | 17 | 10 | 489358 |
| MB45AF11100 | A/F11 | 100 | 17 | 10 | 489369 |
| MB45AF1250 | A/F12 | 50 | 19 | 10 | 489348 |
| MB45AF1275 | A/F12 | 75 | 18 | 10 | 424276 ☆ |
| MB45AF12100 | A/F12 | 100 | 18 | 10 | 424277 ☆ |
| MB45AF12150 | A/F12 | 150 | 18 | 10 | 424278 ☆ |
| MB45AF1350 | A/F13 | 50 | 19 | 10 | 489349 |
| MB45AF1375 | A/F13 | 75 | 19 | 10 | 489360 |
| MB45AF13100 | A/F13 | 100 | 19 | 10 | 489371 |
| MB45AF13150 | A/F13 | 150 | 19 | 10 | 446626 |
| MB45AF1475 | A/F14 | 75 | 20 | 10 | 489361 |
| MB45AF14100 | A/F14 | 100 | 20 | 10 | 489372 |

☆ = Adopts a patented axial press-fit shank technique.

Nutsetter 1/4" Hex Sliding Magnet Nutsetter Metric

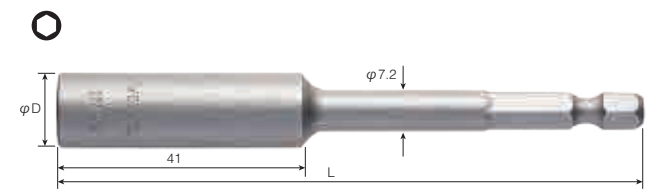

| Model No. | Socket Size | Overall Length | Socket Nose Diameter φ | Inner Ctn. | Code |
|--------------|-------------|----------------|------------------------|------------|--------|
| MB45DAF8100 | A/F8 | 100 | 13 | 10 | 482516 |
| MB45DAF10100 | A/F10 | 100 | 16 | 10 | 482517 |

Nutsetter 1/4" Hex Side Magnet Nutsetter Metric

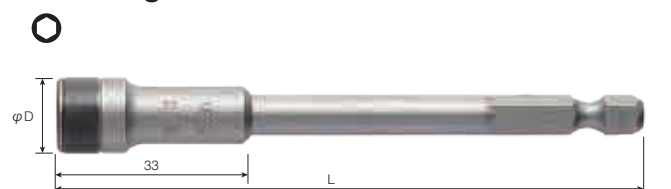

| Model No. | Socket Size | Overall Length | Socket Nose Diameter φ | Inner Ctn. | Code |
|--------------|-------------|----------------|------------------------|------------|--------|
| MB45SAF8100 | A/F8 | 100 | 13 | 10 | 482406 |
| MB45SAF10100 | A/F10 | 100 | 16 | 10 | 482407 |

Features of press-fit type sockets

(Press-fit type: marked with a star symbol in the table of each model)

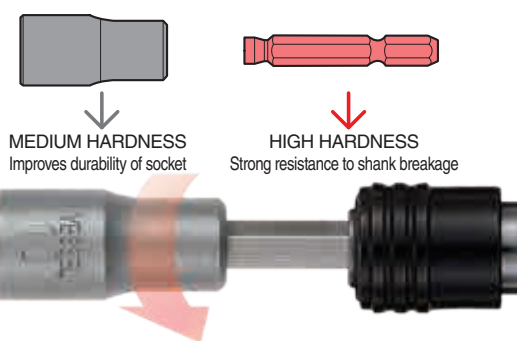

The shank and socket have been heat-treated to the best hardness and press-fit together. The socket part is strong against wear and shank against twisting, resulting in higher durability.

Prevents shank breakage
Torsion moment with a static torque



220USB SERIES

MEGADORA SCREWDRIVER

BALL GRIP SCREWDRIVER

SUPER CUSHION SCREWDRIVER

WOOD COMPO SERIES

FOR ELECTRONICS TOOLS/ USEFUL TOOLS

DRIVER SET SERIES

OTHER HAND TOOLS

L-WRENCH

IMPACT BALL

NECK-TORSION

DRYWALLER/ QB

INSERT BITS

POWER BITS

POWER BITS/ MAG CATCHER

DOUBLE-ENDED POWER BITS

NUT SETTERS

Bit Holder

PRECISION BITS

Bit Holder

220USB SERIES

MEGADORA SCREWDRIVER

BALL GRIP SCREWDRIVER

SUPER CUSHION SCREWDRIVER

WOOD COMPO SERIES

FOR ELECTRONICS TOOLS/ USEFUL TOOLS

DRIVER SET SERIES

OTHER HAND TOOLS

L-WRENCH

IMPACT BALL

NECK-TORSION

DRYWALLER/ QB

INSERT BITS

POWER BITS

POWER BITS/ MAG CATCHER

DOUBLE-ENDED POWER BITS

NUT SETTERS

Bit Holder

PRECISION BITS



TORSION ZONE ABSORB SHOCKS

Torsion part absorbs the impact caused by an impact driver when the screw head is fully seated. It helps preventing tip breakage as much as possible.

NECK TORSION

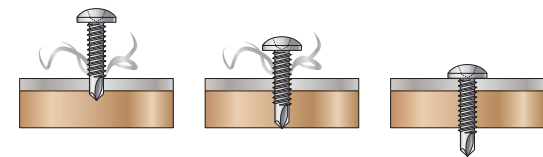

Drive : 1/4 DIN 3126-E6.3, ISO 1173  H 6.35 mm

Bit Holder 1/4" Hex Magnet Bit Holder

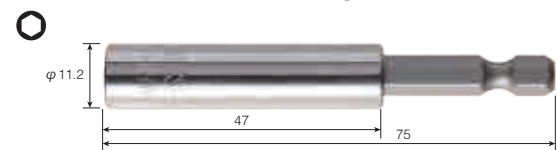

| Model No. | Socket Size | Overall Length | Socket Nose Diameter φ | Inner Ctn. | Code |
|------------|-------------|----------------|------------------------|------------|--------|
| HBMAF63575 | 6.4(1/4") | 75(3") | 11.2(7/16") | 10 | 482425 |

Bit Holder 1/4" Hex Bit Holder w.C-pin

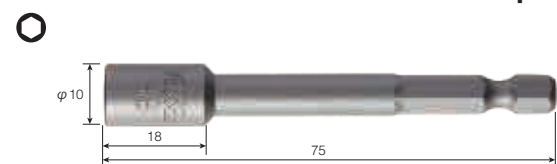

| Model No. | Socket Size | Overall Length | Socket Nose Diameter φ | Inner Ctn. | Code |
|-----------|-------------|----------------|------------------------|------------|--------|
| HBAF63575 | 6.4(1/4") | 75(3") | 10(13/32") | 10 | 482420 |

IMPACT BALL™ Torsion Magnet Bit Holder

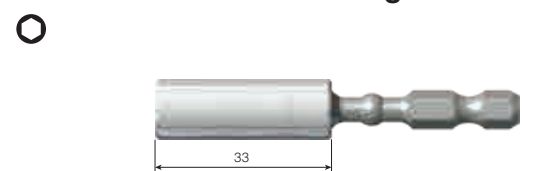

| Model No. | Socket Size | Overall Length | Socket Nose Diameter φ | Inner Ctn. | Code |
|--------------|-------------|----------------|------------------------|------------|--------|
| IBHBM67P10K | 6.4 | 67 | 11.2 | 10 | 426099 |
| IBHBM150P10K | 6.4 | 150 | 11.2 | 10 | 426100 |
| IBHBM300P10K | 6.4 | 300 | 11.2 | 10 | 426101 |

Hex Socket Adapter



| Model No. | Drive Size | Overall Length | Inner Ctn. | Code |
|-------------|------------|----------------|------------|--------|
| B35SA63575 | 6.35 | 75 | 10 | 487382 |
| B35SA635100 | 6.35 | 100 | 10 | 487383 |
| B35SA635150 | 6.35 | 150 | 10 | 487384 |
| B35SA9550 | 9.6 | 50 | 10 | 487391 |
| B35SA9575 | 9.6 | 75 | 10 | 487392 |
| B35SA95100 | 9.6 | 100 | 10 | 487393 |
| B35SA95150 | 9.6 | 150 | 10 | 487394 |

Precision Bits

220USB SERIES

MEGADORA SCREWDRIVER

BALL GRIP SCREWDRIVER

SUPER CUSHION SCREWDRIVER

WOOD COMPO SERIES

FOR ELECTRONICS TOOLS/ USEFUL TOOLS

DRIVER SET SERIES

OTHER HAND TOOLS

L-WRENCH

IMPACT BALL

NECK-TORSION

DRYWALLER/ QB

INSERT BITS

POWER BITS

POWER BITS/ MAG CATCHER

DOUBLE-ENDED POWER BITS

NUT SETTERS

Bit Holder

PRECISION BITS

Drive : 4mm HIOS direct drive  φ 4 mm

Phillips Precision Bit



| Model No. | Tip Size | Overall Length | Diameter (d1) | Length (A) | Inner Ctn. | Code |
|--------------|----------|----------------|---------------|------------|------------|--------|
| D73P00122040 | PH00 | 40 | 1.2 | 20 | 10 | 446001 |
| D73P00152040 | PH00 | 40 | 1.5 | 20 | 10 | 483001 |
| D73P00152060 | PH00 | 60 | 1.5 | 20 | 10 | 483002 |
| D73P00152080 | PH00 | 80 | 1.5 | 20 | 10 | 483003 |
| D73P00172040 | PH00 | 40 | 1.7 | 20 | 10 | 446004 |
| D73P0022040 | PH00 | 40 | 2 | 20 | 10 | 483005 |
| D73P0022060 | PH00 | 60 | 2 | 20 | 10 | 483006 |
| D73P0142040 | PH0 | 40 | 1.4 | 20 | 10 | 446016 |
| D73P0142060 | PH0 | 60 | 1.4 | 20 | 10 | 446017 |
| D73P0142080 | PH0 | 80 | 1.4 | 20 | 10 | 483008 |
| D73P0152040 | PH0 | 40 | 1.5 | 20 | 10 | 446022 |
| D73P0152060 | PH0 | 60 | 1.5 | 20 | 10 | 446076 |
| D73P0172040 | PH0 | 40 | 1.7 | 20 | 10 | 483010 |
| D73P0172060 | PH0 | 60 | 1.7 | 20 | 10 | 483011 |
| D73P0172080 | PH0 | 80 | 1.7 | 20 | 10 | 483012 |
| D73P0182060 | PH0 | 60 | 1.8 | 20 | 10 | 483013 |
| D73P022040 | PH0 | 40 | 2 | 20 | 10 | 446025 |
| D73P022060 | PH0 | 60 | 2 | 20 | 10 | 446026 |
| D73P023060 | PH0 | 60 | 2 | 30 | 10 | 446029 |
| D73P022080 | PH0 | 80 | 2 | 20 | 10 | 446027 |
| D73P0220100 | PH0 | 100 | 2 | 20 | 10 | 446028 |
| D73P0220120 | PH0 | 120 | 2 | 20 | 10 | 483014 |
| D73P0252040 | PH0 | 40 | 2.5 | 20 | 10 | 483015 |
| D73P0252060 | PH0 | 60 | 2.5 | 20 | 10 | 483016 |
| D73P0252080 | PH0 | 80 | 2.5 | 20 | 10 | 446033 |
| D73P02520100 | PH0 | 100 | 2.5 | 20 | 10 | 446034 |
| D73P02520120 | PH0 | 120 | 2.5 | 20 | 10 | 483017 |
| D73P1252040 | PH1 | 40 | 3 | 20 | 10 | 446048 |
| D73P132040 | PH1 | 40 | 3 | 20 | 10 | 483021 |
| D73P132060 | PH1 | 60 | 3 | 20 | 10 | 446053 |
| D73P132080 | PH1 | 80 | 2 | 20 | 10 | 446054 |
| D73P1320100 | PH1 | 100 | 3 | 20 | 10 | 446055 |
| D73P1320120 | PH1 | 120 | 3 | 20 | 10 | 483376 |
| D73P140 | PH1 | 40 | 4 | - | 10 | 483025 |
| D73P160 | PH1 | 60 | 4 | - | 10 | 446059 |
| D73P180 | PH1 | 80 | 4 | - | 10 | 483026 |
| D73P1100 | PH1 | 100 | 4 | - | 10 | 483027 |
| D73P1120 | PH1 | 120 | 4 | - | 10 | 483028 |
| D73P1150 | PH1 | 150 | 4 | - | 10 | 483029 |
| D73P1200 | PH1 | 200 | 4 | - | 10 | 483032 |
| D73P240 | PH2 | 40 | 4 | - | 10 | 483031 |
| D73P260 | PH2 | 60 | 4 | - | 10 | 446070 |
| D73P280 | PH2 | 80 | 4 | - | 10 | 446071 |
| D73P2100 | PH2 | 100 | 4 | - | 10 | 446072 |
| D73P2120 | PH2 | 120 | 4 | - | 10 | 446073 |
| D73P2150 | PH2 | 150 | 4 | - | 10 | 483033 |

Slotted Precision Bit

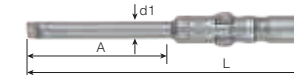

| Model No. | Overall Length | Tip Width/ Shank Diameter | Length (A) | Inner Ctn. | Code |
|------------|----------------|---------------------------|------------|------------|--------|
| D73S20340 | 40 | 2 | 20 | 10 | 483041 |
| D73S250340 | 40 | 2.5 | 20 | 10 | 483042 |
| D73S30440 | 40 | 3 | 20 | 10 | 483043 |
| D73S40540 | 40 | 4 | - | 10 | 483044 |

Hex Precision Bit

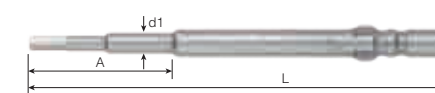

| Model No. | Tip Size | Overall Length | Diameter (d1) | Length (A) | Inner Ctn. | Code |
|-------------|----------|----------------|---------------|------------|------------|--------|
| D73H1522060 | H1.5 | 60 | 2 | 20 | 10 | 483051 |
| D73H232060 | H2 | 60 | 3 | 20 | 10 | 483052 |
| D73H2532060 | H2.5 | 60 | 3 | 20 | 10 | 483053 |
| D73H3360 | H3 | 60 | 4 | - | 100 | 483054 |

Torx Precision Bit

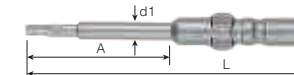

| Model No. | Tip Size | Overall Length | Diameter (d1) | Length (A) | Inner Ctn. | Code |
|-------------|----------|----------------|---------------|------------|------------|--------|
| D73T1152040 | T1 | 40 | 1.5 | 20 | 10 | 635621 |
| D73T2152040 | T2 | 40 | 1.5 | 20 | 10 | 635622 |
| D73T3172040 | T3 | 40 | 1.7 | 20 | 10 | 635623 |
| D73T4182040 | T4 | 40 | 1.8 | 20 | 10 | 635624 |
| D73T522040 | T5 | 40 | 2 | 20 | 10 | 635625 |
| D73T522060 | T5 | 60 | 2 | 20 | 10 | 446108 |
| D73T6252040 | T6 | 40 | 2.5 | 20 | 10 | 635626 |
| D73T622040 | T6 | 40 | 2 | 20 | 10 | 446109 |
| D73T622060 | T6 | 60 | 2 | 20 | 10 | 446110 |
| D73T7252040 | T7 | 40 | 2.5 | 20 | 10 | 635627 |
| D73T722060 | T7 | 60 | 2 | 20 | 10 | 446113 |
| D73T832040 | T8 | 40 | 3 | 20 | 10 | 635628 |
| D73T932040 | T9 | 40 | 3 | 20 | 10 | 635629 |
| D73T1032040 | T10 | 40 | 3 | 20 | 10 | 635630 |
| D73T10H60 | T10H | 60 | 4 | - | 10 | 446119 |

Precision Bits

Drive : 5mm HIOS direct drive

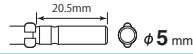

Phillips Precision Bit

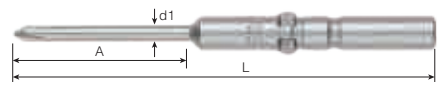

| Model No. | Tip Size | Overall Length | Diameter (d1) | Length (A) | Inner Ctn. | Code |
|--------------|----------|----------------|---------------|------------|------------|--------|
| D76P0022060 | PH00 | 60 | 2 | 20 | 10 | 483105 |
| D76P022560 | PH0 | 60 | 2 | 25 | 10 | 483106 |
| D76P0252560 | PH0 | 60 | 2.5 | 25 | 10 | 483115 |
| D76P02525100 | PH0 | 100 | 2.5 | 25 | 10 | 483117 |
| D76P133060 | PH1 | 60 | 3 | 30 | 10 | 483121 |
| D76P133080 | PH1 | 80 | 3 | 30 | 10 | 446267 |
| D76P1330100 | PH1 | 100 | 3 | 30 | 10 | 483122 |
| D76P1330120 | PH1 | 120 | 3 | 30 | 10 | 483123 |
| D76P160 | PH1 | 60 | 5 | - | 10 | 483125 |
| D76P1100 | PH1 | 100 | 5 | - | 10 | 483127 |
| D76P1200 | PH1 | 200 | 5 | - | 10 | 483132 |
| D76P260 | PH2 | 60 | 5 | - | 10 | 483131 |
| D76P280 | PH2 | 80 | 5 | - | 10 | 446279 |
| D76P2100 | PH2 | 100 | 5 | - | 10 | 446280 |
| D76P2120 | PH2 | 120 | 5 | - | 10 | 446281 |
| D76P2150 | PH2 | 150 | 5 | - | 10 | 446282 |
| D76P2200 | PH1 | 200 | 5 | - | 10 | 483137 |

Torx Precision Bit



| Model No. | Tip Size | Overall Length | Diameter (d1) | Length (A) | Inner Ctn. | Code |
|-------------|----------|----------------|---------------|------------|------------|--------|
| D76T522060 | T5 | 60 | 2 | 20 | 10 | 635651 |
| D76T6252060 | T6 | 60 | 2.5 | 20 | 10 | 635652 |
| D76T7252060 | T7 | 60 | 2.5 | 20 | 10 | 635653 |
| D76T832060 | T8 | 60 | 3 | 20 | 10 | 635654 |
| D76T932060 | T9 | 60 | 3 | 20 | 10 | 635655 |
| D76T1032060 | T10 | 60 | 3 | 20 | 10 | 635656 |
| D76T1542060 | T15 | 60 | 4 | 20 | 10 | 635657 |
| D76T2060 | T20 | 60 | 5 | - | 10 | 635658 |
| D76T2560 | T25 | 60 | 5 | - | 10 | 635659 |

Drive : 4mm HIOS direct drive

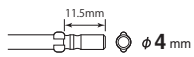

Nutsetter



| Model No. | Socket Size | Overall Length | Socket Nose Diameter phi | Inner Ctn. | Code |
|-----------|-------------|----------------|--------------------------|------------|--------|
| D73AF460 | A/F4 | 60 | 8 | 10 | 483924 |
| D73AF560 | A/F5 | 60 | 8 | 10 | 483926 |
| D73AF5560 | A/F5.5 | 60 | 8 | 10 | 483927 |

Drive : 4mm half moon direct drive

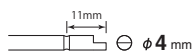

Phillips Precision Bit

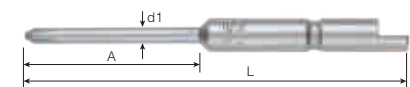

| Model No. | Tip Size | Overall Length | Diameter (d1) | Length (A) | Inner Ctn. | Code |
|------------|----------|----------------|---------------|------------|------------|--------|
| D71P001544 | PH00 | 44 | 1.5 | 20 | 10 | 482901 |
| D71P001564 | PH00 | 64 | 1.5 | 20 | 10 | 482902 |
| D71P0244 | PH0 | 44 | 2 | 20 | 10 | 482911 |
| D71P0264 | PH0 | 64 | 2 | 20 | 10 | 482912 |
| D71P02544 | PH0 | 44 | 2.5 | 20 | 10 | 482913 |
| D71P02564 | PH0 | 64 | 2.5 | 20 | 10 | 482914 |
| D71P1344 | PH1 | 44 | 3 | 20 | 10 | 482921 |
| D71P1364 | PH1 | 64 | 3 | 20 | 10 | 482922 |
| D71P1444 | PH1 | 44 | 4 | 20 | 10 | 482923 |
| D71P1464 | PH1 | 64 | 4 | 20 | 10 | 482924 |
| D71P2444 | PH2 | 44 | 4 | 20 | 10 | 482931 |
| D71P2464 | PH2 | 64 | 4 | 20 | 10 | 482932 |

Slotted Precision Bit

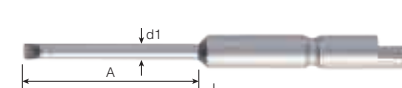

| Model No. | Overall Length | Tip Width/ Shank Diameter | Length (A) | Inner Ctn. | Code |
|------------|----------------|---------------------------|------------|------------|--------|
| D71S20344 | 44 | 2 | 20 | 10 | 482941 |
| D71S250344 | 44 | 2.5 | 20 | 10 | 482942 |
| D71S30444 | 44 | 3 | 20 | 10 | 482943 |
| D71S40544 | 44 | 4 | 20 | 10 | 482944 |

Hex Precision Bit

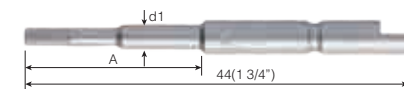

| Model No. | Tip Size | Overall Length | Diameter (d1) | Length (A) | Inner Ctn. | Code |
|-----------|----------|----------------|---------------|------------|------------|--------|
| D71H15244 | H1.5 | 44 | 2 | 20 | 10 | 482951 |
| D71H2344 | H2 | 44 | 3 | 20 | 10 | 482952 |
| D71H25344 | H2.5 | 44 | 3 | 20 | 10 | 482953 |
| D71H3444 | H3 | 44 | 4 | - | 10 | 482954 |

Torx Precision Bit

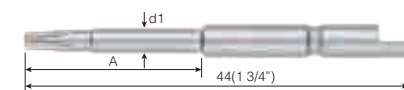

| Model No. | Tip Size | Overall Length | Diameter (d1) | Length (A) | Inner Ctn. | Code |
|-----------|----------|----------------|---------------|------------|------------|--------|
| D71T144 | T1 | 44 | 1.5 | 20 | 10 | 635601 |
| D71T244 | T2 | 44 | 1.5 | 20 | 10 | 635602 |
| D71T344 | T3 | 44 | 1.7 | 20 | 10 | 635603 |
| D71T444 | T4 | 44 | 1.8 | 20 | 10 | 635604 |
| D71T544 | T5 | 44 | 2.5 | 20 | 10 | 635605 |
| D71T644 | T6 | 44 | 2.5 | 20 | 10 | 635606 |
| D71T744 | T7 | 44 | 2.5 | 20 | 10 | 635607 |
| D71T844 | T8 | 44 | 3 | 20 | 10 | 635608 |
| D71T944 | T9 | 44 | 3 | 20 | 10 | 635609 |
| D71T1044 | T10 | 44 | 3 | 20 | 10 | 635610 |
| D71T8H44 | T8H | 44 | 4 | - | 10 | 446323 |
| D71T15H44 | T15H | 44 | 4 | - | 10 | 446328 |

Torx Plus Precision Bit

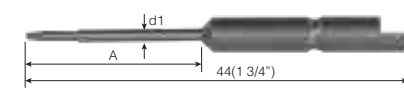

| Model No. | Tip Size | Overall Length | Diameter (d1) | Length (A) | Inner Ctn. | Code |
|-----------|----------|----------------|---------------|------------|------------|--------|
| D71IP244 | 2IP | 44 | 4 | 00 | 10 | 447428 |
| D71IP264 | 2IP | 64 | 4 | 00 | 10 | 447412 |
| D71IP344 | 3IP | 44 | 4 | 00 | 10 | 447429 |
| D71IP364 | 3IP | 64 | 4 | 00 | 10 | 447413 |

Nutsetter Precision Bit

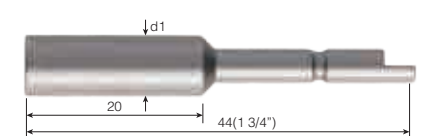

| Model No. | Tip Size | Overall Length | Diameter (d1) | Inner Ctn. | Code |
|-----------|----------|----------------|---------------|------------|--------|
| D72AF444 | A/F4 | 44 | 7 | 10 | 482961 |
| D72AF4544 | A/F4.5 | 44 | 7 | 10 | 482962 |
| D72AF544 | A/F5 | 44 | 8 | 10 | 482963 |
| D72AF5544 | A/F5.5 | 44 | 8 | 10 | 482964 |

Drive : M5/M6



Screw Shank Driver Bit



| Model No. | Tip Size | Overall Length | Screw Pitch | Inner Ctn. | Code |
|-----------|----------|----------------|-------------|------------|--------|
| M4P07P134 | PH1 | 34 | P0.7 | 10 | 489656 |
| M4P07P234 | PH2 | 34 | P0.7 | 10 | 489657 |

Torx ShoBits for screw fastening robots (Semi-standardized items)

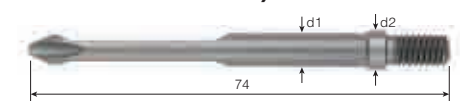

| Model No. | Tip Size | Overall Length | Diameter (d1) | Diameter (d2) | Screw Pitch | Inner Ctn. | Code |
|-----------|----------|----------------|---------------|---------------|-------------|------------|--------|
| M5P08P274 | PH2 | 74 | 5.0 | 6.0 | P0.8 | 10 | 483301 |
| M6P1P274 | PH2 | 74 | 6.0 | 7.0 | P1.0 | 10 | 483302 |

Torx ShoBits for screw fastening robots (Semi-standardized items)

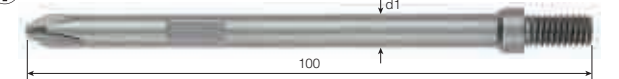

| Model No. | Tip Size | Overall Length | Diameter (d1) | Screw Pitch | Inner Ctn. | Code |
|-----------|----------|----------------|---------------|-------------|------------|--------|
| M6P1P2100 | PH2 | 100 | 6.0 | P1.0 | 10 | 483303 |